

## 1. Description

The KNX4660A-Channel enhancement mode silicon gate power MOSFET is designed for high voltage, high speed power switching applications such as high efficiency switched mode power supplies, active power factor correction, electronic lamp ballasts based on half bridge topology.

## 2. Features

- n ROHS Compliant
- n  $R_{DS(ON),typ}=1.0\Omega@V_{GS}=10V$
- n Low Gate Charge Minimize Switching Loss
- n Fast Recovery Body Diode

## 3. Application

- n Adaptor
- n Charger
- n SMPS Standby Power

## 4. Pin configuration

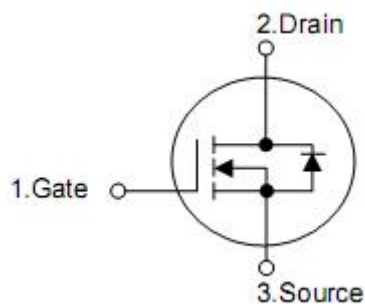
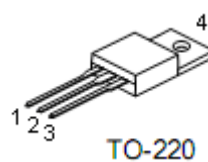
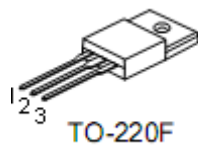

Pin	Function
1	Gate
2	Drain
3	Source
4	Drain

## 5. Ordering Information

Part Number	Package	Brand
KNF4660A	TO-220F	KIA
KNP4660A	TO-220	KIA

## 6. Absolute maximum ratings

TC=25°C unless otherwise specified

Parameter	Symbol	Ratings		Unit
		TO-220F	TO-220	
Drain-to-Source Voltage	$V_{DSS}$	600		V
Gate-to-Source Voltage	$V_{GSS}$	±30		
Continuous Drain Current	$I_D$	7.0		A
Pulsed Drain Current at $V_{GS}=10V$	$I_{DM}$	28		
Single Pulse Avalanche Energy	$E_{AS}$	550		mJ
Power Dissipation	$P_D$	42	128	W
Derating Factor above 25 °C		0.34	1.03	W/ °C
Maximum Temperature for Soldering Leads at 0.063in (1.6mm) from Case for 10 seconds, Package Body for 10 seconds	$T_L$ $T_{PAK}$	300 260		°C
Operating and Storage Temperature Range	$T_J$ & $T_{STG}$	-55 to 150		

Caution: Stresses greater than those listed in the "Absolute Maximum Ratings" may cause permanent damage to the device.

## 7. Thermal characteristics

Parameter	Symbol	Ratings		Units
		TO-220F	TO-220	
Thermal resistance, junction-ambient	$R_{\theta JA}$	100	-	°C/W
Thermal resistance, Junction-case	$R_{\theta JC}$	2.98	0.97	

## 8. Electrical characteristics

( $T_J=25^\circ\text{C}$ , unless otherwise notes)

Parameter	Symbol	Conditions	Min	Typ	Max	Units
Off characteristics						
Drain-source breakdown voltage	$BV_{DSS}$	$V_{GS}=0V, I_D=250\mu A$	600	-	-	V
Drain-to-source Leakage Current	$I_{DSS}$	$V_{DS}=600, V_{GS}=0V$	-	-	1	$\mu A$
		$V_{DS}=480, V_{GS}=0V$ $T_J=125^\circ\text{C}$ ,	-	-	100	$\mu A$
Gate-body leakage current	$I_{GSS}$	$V_{GS}=30V, V_{DS}=0V$	-	-	+100	nA
		$V_{GS}=-30V, V_{DS}=0V$	-	-	-100	nA
On characteristics						
Static drain-source on-resistance	$R_{DS(on)}$	$V_{GS}=10V, I_D=3.5A$	-	1.0	1.25	$\Omega$
Gate threshold voltage	$V_{GS(th)}$	$V_{DS}=V_{GS}, I_D=250\mu A$	2.0	-	4.0	V
Forward Transconductance	$g_{fs}$	$V_{DS}=30V, I_D=3.5A$	-	11	-	S
Dynamic characteristics						
Input capacitance	$C_{iss}$	$V_{DS}=25V, V_{GS}=0V,$ $f=1\text{MHz}$	-	1120	-	pF
Output capacitance	$C_{oss}$		-	90	-	pF
Reverse transfer capacitance	$C_{rss}$		-	10	-	pF
Total gate charge						
Turn-on delay time	$t_{d(on)}$	$V_{DD}=300V, I_D=7A,$ $V_{GS}=10V, R_G=4.7\Omega$	-	10	-	ns
Rise time	$t_r$		-	11	-	ns
Turn-off delay time	$t_{d(off)}$		-	17	-	ns
Fall time	$t_f$		-	10	-	ns
Total gate charge	$Q_g$	$V_{DD}=300V, I_D=7A,$ $V_{GS}=0 \text{ to } 10V$	-	19	-	nC
Gate-source charge	$Q_{gs}$		-	5	-	nC
Gate-drain charge	$Q_{gd}$		-	5	-	nC
Drain-source diode characteristics						
Drain-source diode forward voltage	$V_{SD}$	$V_{GS}=0V, I_S=7A$	-	-	1.5	V
Continuous drain-source current [2]	$I_{SD}$	Integral pn-diode In MOSFET	-	-	7.0	A
Pulsed drain-source current [2]	$I_{SM}$		-	-	28	A
Reverse recovery time	$t_{rr}$	$V_{GS}=0V, I_F=7A$	-	349	-	ns
Reverse recovery charge	$Q_{rr}$	$di_{SD}/dt=100A/\mu s$	-	1.0	-	$\mu C$

Note: [1]  $T_J=+25^\circ\text{C}$  to  $+150^\circ\text{C}$

[2] Pulse width  $\leq 380\mu s$ ; duty cycle  $\leq 2\%$ .

## 9. Typical Characteristics

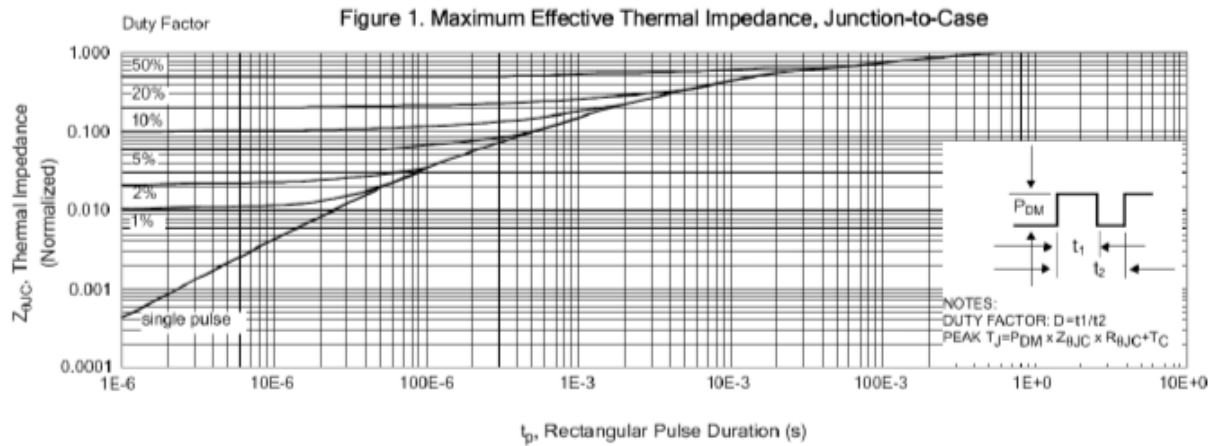

**Figure 2. Maximum Power Dissipation vs Case Temperature**

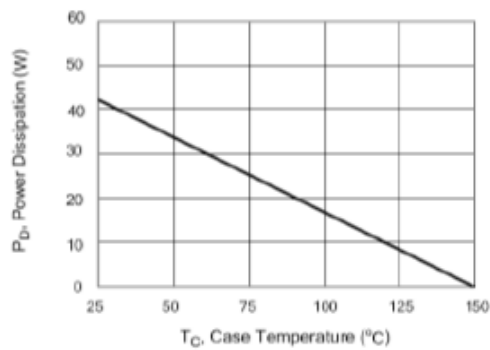

**Figure 3. Maximum Continuous Drain Current vs Case Temperature**

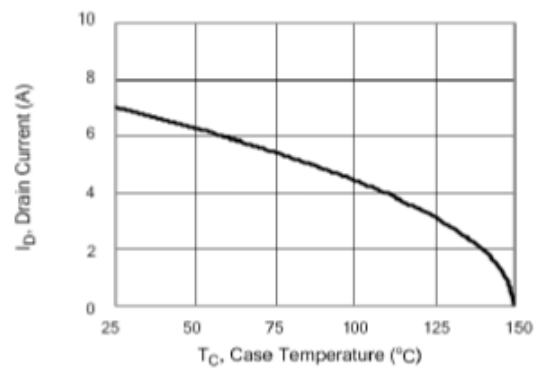

**Figure 4. Typical Output Characteristics**

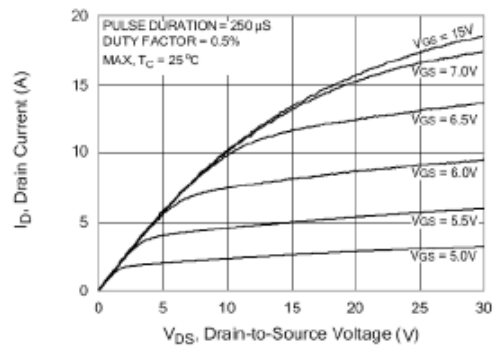

**Figure 5. Typical Drain-to-Source ON Resistance vs Gate Voltage and Drain Current**

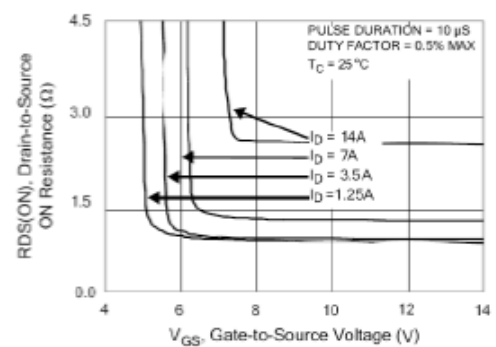

Figure 6. Maximum Peak Current Capability

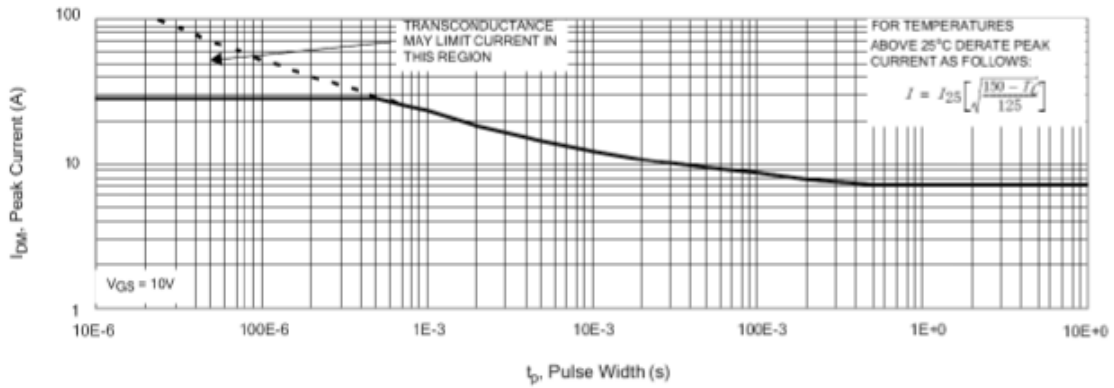

Figure 7. Typical Transfer Characteristics

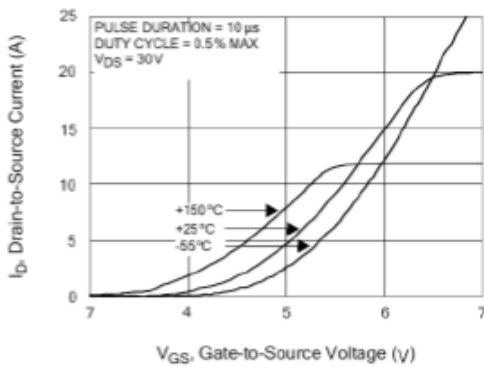

Figure 8. Unclamped Inductive Switching Capability

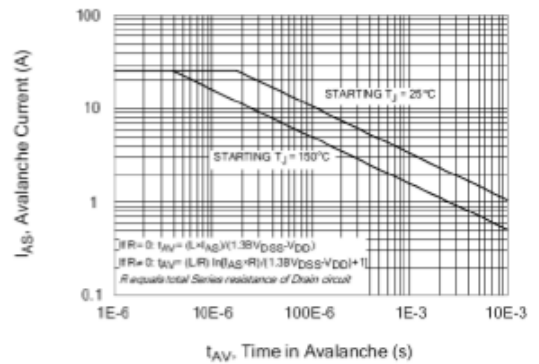

Figure 9. Typical Drain-to-Source ON Resistance vs Drain Current

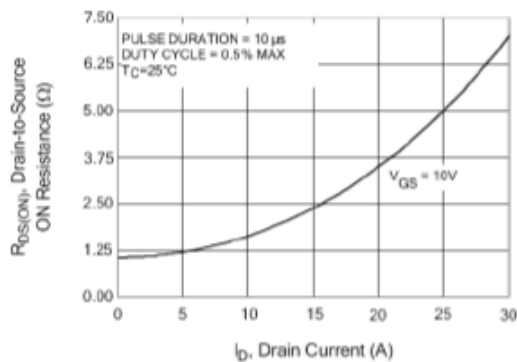
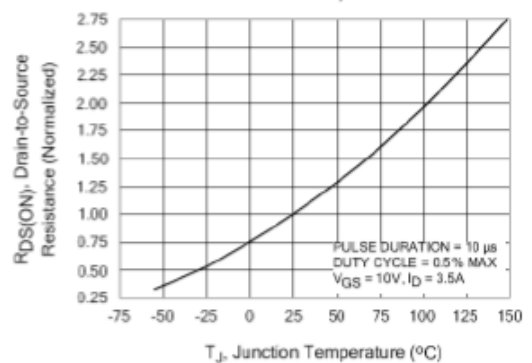
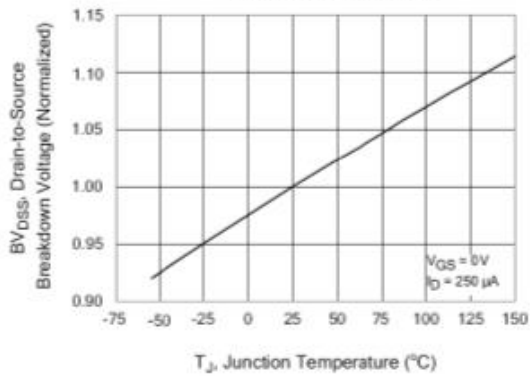

Figure 10. Typical Drain-to-Source ON Resistance vs Junction Temperature



**Figure 11. Typical Breakdown Voltage vs Junction Temperature**



**Figure 12. Typical Threshold Voltage vs Junction Temperature**

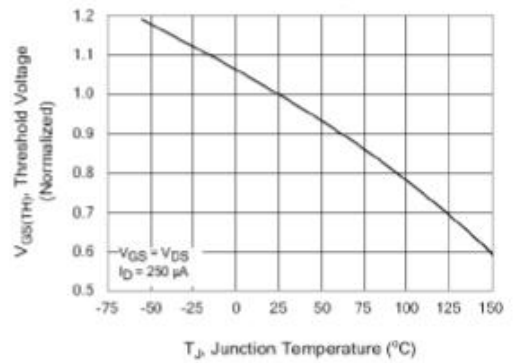

**Figure 13. Maximum Forward Bias Safe Operating Area**

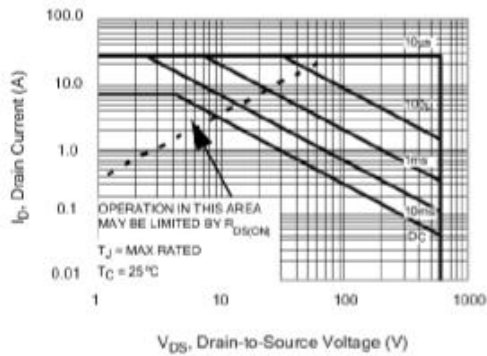

**Figure 14. Typical Capacitance vs Drain-to-Source Voltage**

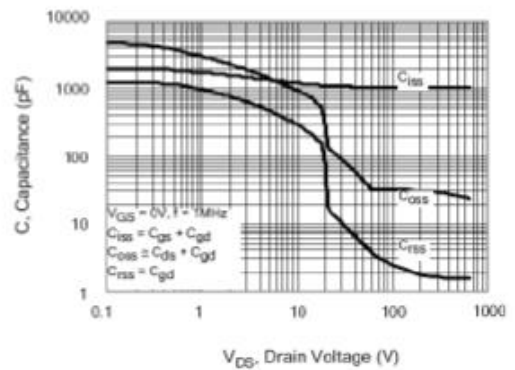

**Figure 15. Typical Gate Charge**

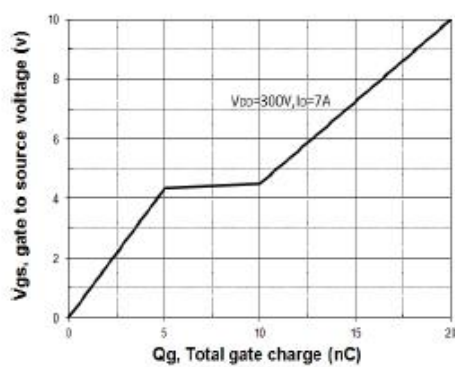

**Figure 16. Typical Body Diode Transfer Characteristics**

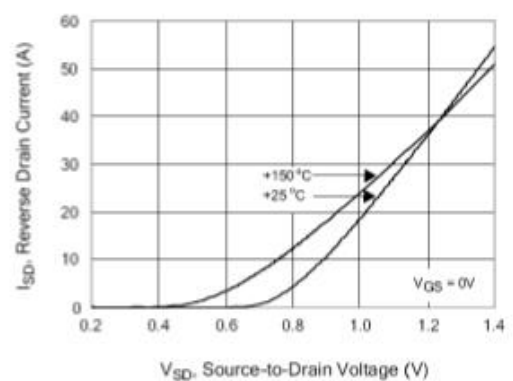

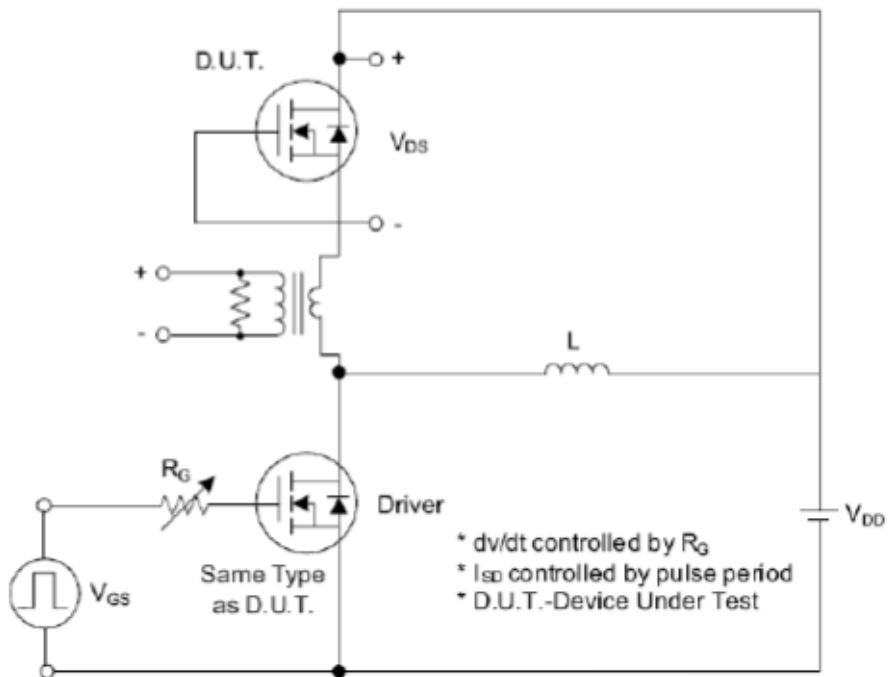

Fig. 1.1 Peak Diode Recovery  $dv/dt$  Test Circuit

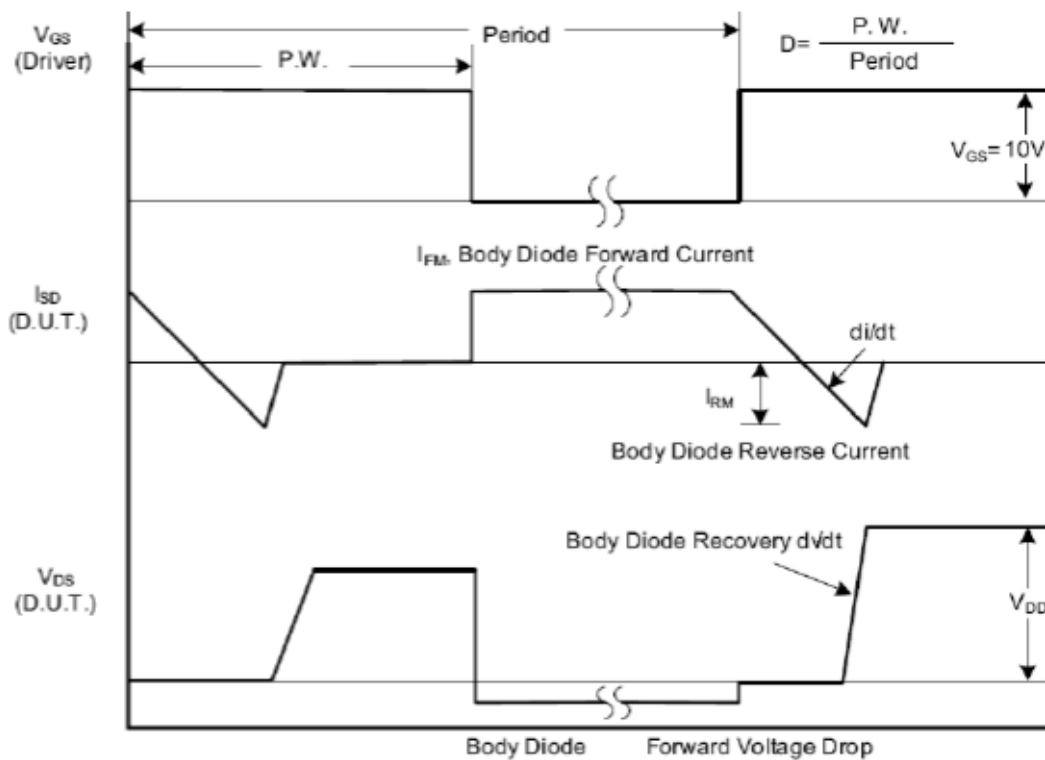

Fig. 1.2 Peak Diode Recovery  $dv/dt$  Waveforms

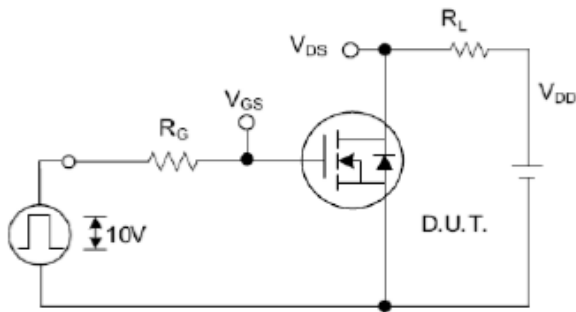

Fig. 2.1 Switching Test Circuit

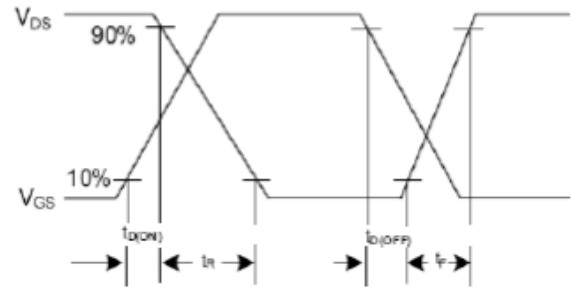

Fig. 2.2 Switching Waveforms

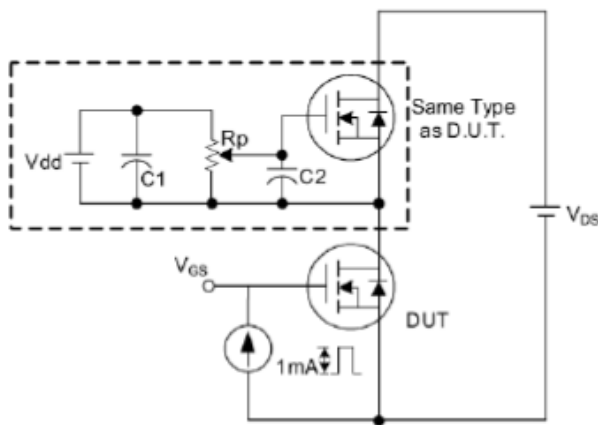

Fig. 3.1 Gate Charge Test Circuit

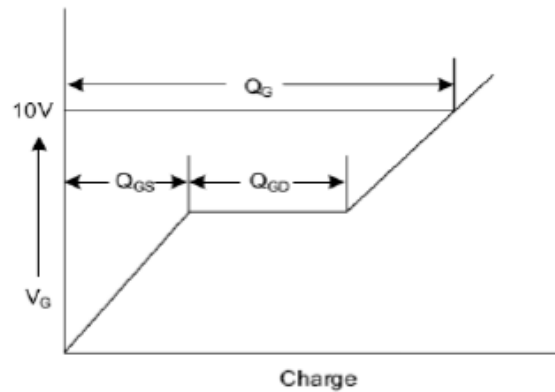

Fig. 3.2 Gate Charge Waveform

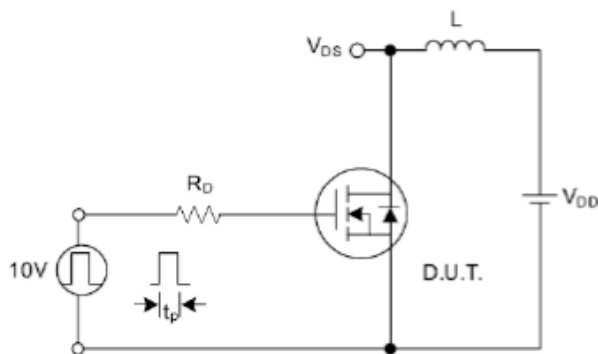

Fig. 4.1 Unclamped Inductive Switching Test Circuit

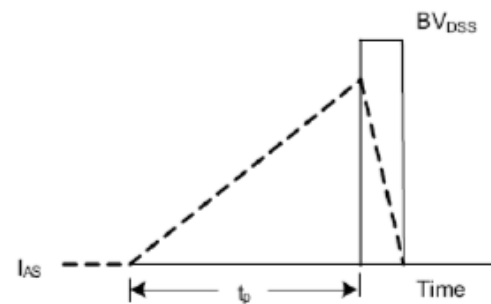

Fig. 4.2 Unclamped Inductive Switching Waveforms